



MOBOTIX S15D
with 2 x Thermal Sensor Module
or
Thermal Sensor Module and
Standard Sensor Module

- S15D: Modular PoE network camera with max. two sensor modules for concealed installation
- All components weatherproof (S15D: IP65, Thermal Sensor Module: IP66), -30 to +60°C/-22 to 140°F
- Thermal and standard sensor modules can be freely combined
- Sensor module connection cables max. 2 m each (e.g., for indoors/outdoors)

Sensor module with high-end thermal sensor and 43/65/135 mm focal length for MOBOTIX S15D; optionally one or two thermal sensor modules or one thermal and one standard-sensor module (Day/Night/LPF) can be connected

Standard Delivery

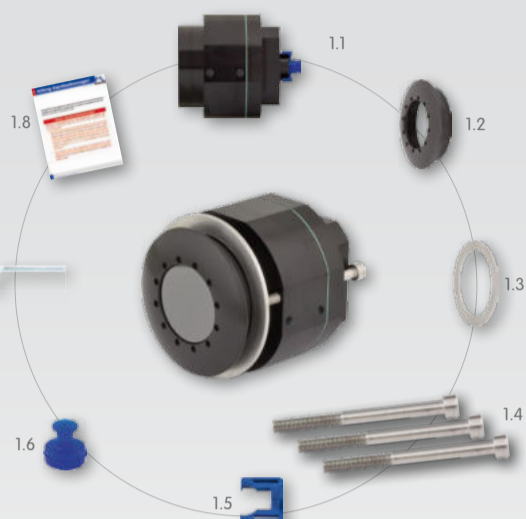

Item	Count	Part Name
1.1	1	MX-SM-Thermal-L43/65/135 body, black anodized
1.2	1	Front plate aluminum, black anodized (installed)
1.3	1	Pressure plate Ø 63 mm/2.48 in, stainless steel (installed)
1.4	3	Cylinder head screws M4x50 mm, stainless steel (installed)
1.5	1	Cable lock, blue (installed)
1.6	1	Sealing plug blue, small (installed)
1.7	1	Allen wrench 3 mm
1.8	1	Special export regulations German/English

Available Focal Lengths

Example image	MX-SM-Thermal-L43	MX-SM-Thermal-L65	MX-SM-Thermal-L135
Article number	MX-SM-Thermal-L43	MX-SM-Thermal-L65	MX-SM-Thermal-L135
Focal length (≅35 mm)	43 mm	65 mm	135 mm
Actual focal length	7.5 mm	13 mm	19 mm
Horizontal image angle	45°	25°	17°

Example for Connecting Thermal Sensor Modules to the S15D



Power supply (e.g., PoE switch)

MX-Overvoltage-Protection-Box
(highly recommended!)

S15D

Thermal Sensor Modules

Caution!

When using a MOBOTIX S15D, on which the PoE class setting had been changed manually from the factory default to PoE Class 2 before, you need to set the camera to use PoE Class 3 before connecting the sensor modules!

Proceed as outlined in the following:

- Install the camera and the sensor modules.
- Make sure that the sensor modules are **not** connected to the camera.
- Connect the power supply and start the camera.
- Set the camera to PoE Class 3 (see camera manual) and set the modules that are to be used.
- Disconnect the camera's power supply.
- Connect the sensor modules to the S15D.
- Reconnect the power supply of the camera.

Installing the S15D

Step 1: Install the S15D

- Install the MOBOTIX S15D at a suitable location.
- Make sure that you follow the instructions in *Chapter 2* of the *S15D Camera Manual*.



Step 2: Install and Connect the Sensor Cables to the S15D

- Guide the required MOBOTIX sensor cable (not included in delivery) from the S15D to the location of the sensor modules and attach the hinged ferrites to both ends of the sensor cable.



- Connect the sensor cable to the S15D as described in the S15 Camera Manual.

Installation Variant 1: Front Plate Installation Behind Wall/Faceplate

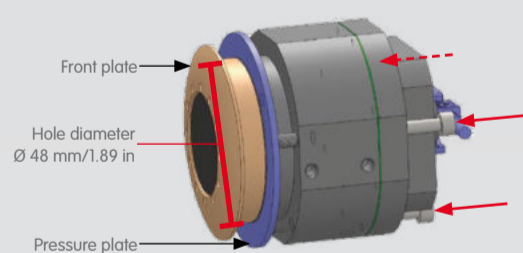

Tighten the cylinder head screws (red arrows) to push the pressure plate against the wall/faceplate.
Hole diameter Ø 48 mm/1.89 in
Possible thickness of wall/faceplate: 0 to 14 mm/0 to 0.6 in

Step 1: Prepare the Installation Location

- Drill a **hole with 48 mm/1.89 in diameter** into the wall or faceplate.

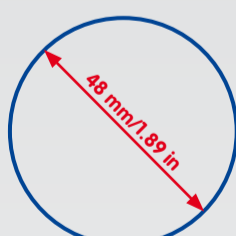

Step 2: Attach the Thermal Sensor Module

- Open the blue lock at the back of the module (1) and remove the blue sealing plug (2).
- Push the connector of the blue MOBOTIX sensor cable (not included in delivery) into the receptacle so that the connector is fully inserted.
- Close the blue lock at the back of the module housing.

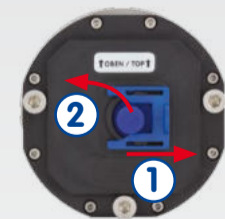

Step 3: Install the Thermal Sensor Module

- Using the black module wrench, unscrew the front plate of the module (part of the delivery of the S15D).
- Loosen the cylinder head screws until the pressure plate rests against the sensor module housing.
- Push the module from behind through the hole you just drilled.
- Screw the front plate back into the module and tighten the front plate using the module wrench.
- Fasten the module by evenly tightening the cylinder head screws using the 3 mm Allen wrench. This will push the pressure plate against the wall and hold the module in place. Make sure that the **OBEN / TOP** sticker at the back of the module is pointing upwards.

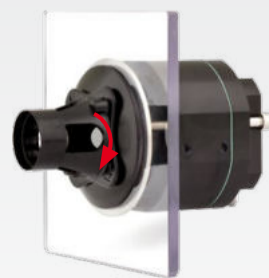
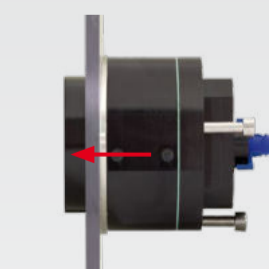

Continue to bring the camera into service as described in *Section «Initial Operation S15D with Thermal Sensor Module»*.

Installation Variant 2: Screw Mounting

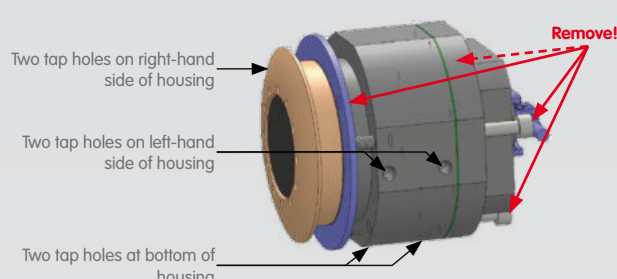

The housing can be installed by affixing suitable screws M4 (4 mm length of thread) in at least two of the six tap holes. Remove pressure plate and cylinder head screws.

Step 1: Prepare the Installation Location

- Prepare a suitable attachment for the Thermal Sensor Module. At least two screws are required to securely fasten the module.
- Make sure that the **OBEN/TOP** sticker at the back of the module is pointing upwards.

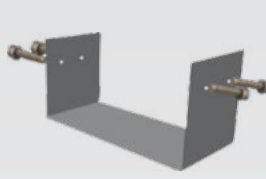

Step 2: Prepare the Thermal Sensor Module

- Using the black module wrench, unscrew the front plate of the module (part of the delivery of the S15D).
- Remove the cylinder head screws and the pressure plate.
- Screw the front plate back into the module and tighten the front plate using the black module wrench.



Step 3: Attach the Thermal Sensor Module

- Open the blue lock at the back of the module (1) and remove the blue sealing plug (2).

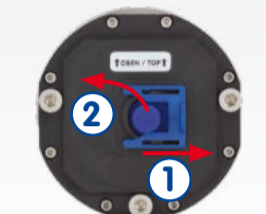

- Push the connector of the blue MOBOTIX sensor cable into the receptacle so that the connector is fully inserted.

- Close the blue lock at the back of the module housing.



Step 4: Install the Thermal Sensor Module

- Fasten the module by applying at least two suitable screws M4 to the tap holes. The tap holes are at the right-hand side, the left-hand side and at the bottom of the module (see Section «Dimensions/Drilling Templates» further below).

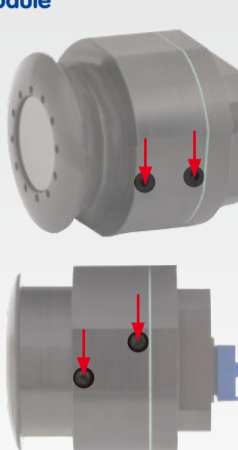

Continue to bring the camera into service as described in Section «Initial Operation S15D with Thermal Sensor Module».

Initial Operation S15D with Thermal Sensor Module

Step 1: Establish Network Connection and Power Supply

- Connect the network port to a router or switch (see S15 Camera Manual, Section «Network and Power Connection, Additional Cables»).
- If you do not use a PoE switch, establish the power supply of the camera (using a PoE Power Adapter/MX-NPA-Box).
- Configure the camera for your network (see S15 Camera Manual, Section «Manual and Automatic Operation»).

Step 2: Open User Interface in Browser

- Monitor the camera LEDs and make sure that the S15D is ready (green LED is on, red LED flashes slowly; see S15 Camera Manual, Section «Camera Startup Sequence»).
- Enter the IP address of the camera you determined in Step 1 in the address bar of the browser.

Step 3: Set Installed Thermal Sensor Modules

- In the camera's browser interface, click on the **Admin Menu** button and in the **Hardware Configuration** section, open the **Image Sensor Configuration** dialog.
- Use the dropdown fields (**Left Sensor**, **Right Sensor**) to select the camera ports (*External sensor Cam1*, *External sensor Cam2*) to which you will connect thermal image sensors.
- You can also use this section to select the sensor module (*External sensor Cam1*, *External sensor Cam2*) that will be shown at the left (**Left Sensor**) or at the right (**Right Sensor**) in the dual image.
- Close the dialog and save the configuration of the camera.

Dimensions/Drilling Templates

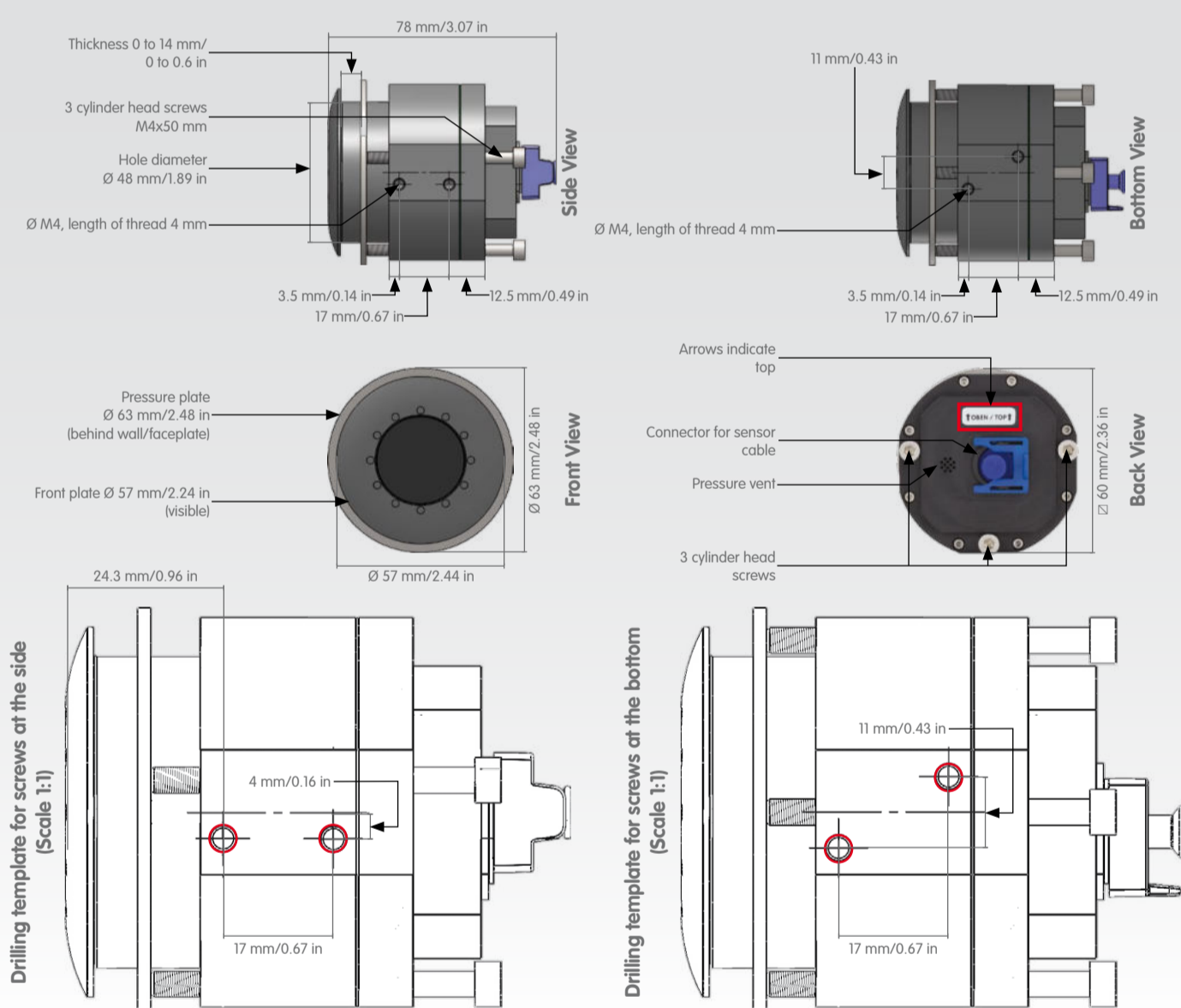

Notes

- This product must not be used in locations exposed to the dangers of explosion.
- Make sure that you install the S15D and this product as outlined in the installation instructions in this document and in Chapter 2, «Installation» of the S15 Camera Manual (www.mobotix.com > Support > Manuals).
- When installing this product, make sure that you are only using genuine MOBOTIX parts and MOBOTIX connection cables.
- Only install this product in or on suitable, solid materials that provide for a sturdy installation of the fixing elements used.
- Always observe the special export regulations (see supplied **Special Export Regulations**).
- The Thermal Sensor Module is only to be used in combination with the MOBOTIX S15D.
- The Thermal Sensor Module requires a software release MX-V4.2.1 or higher on the MOBOTIX S15D.
- In contrast to the standard sensor modules, the Thermal Sensor Module does not have either a microphone or LEDs. When running the camera without standard sensor module, you need to attach an external microphone if you need this feature. This also means that the operating status of the camera is only shown by the LEDs on the camera body.
- Glass panes are blocking thermal radiation! Make sure that there aren't any glass panes between the Thermal Sensor Module and the objects that are to be observed.
- Make sure that the operating temperature of -30 to +60°C/-22 to 140°F is not exceeded.

Technical Specifications

Thermal Sensor Module	
Lens Options	L43 (45°), L65 (25°), L135 (17°) (horizontal field of view)
Sensitivity	NETD typ. 50 mK (equals 0.05°C), <79 mK
Image Sensor	Uncooled microbolometer, 336x252 pixels, spectral range 7.5 to 13.5 µm
Temperature Measurement Range	-40 to +550°C/-40 to 1,022°F (temperature of the displayable objects)
Max. Image Size	Can be scaled up to 2048x1536 (QXGA), dual images are automatically scaled to size of the standard sensor module
Max. Frame Rate	9 fps (when displaying a standard sensor module and a thermal sensor module, the overall frame rate of the camera is reduced to 9 fps)
Software Features	Off-color/black & white image display, mirrored image, obscured image areas, vPTZ (virtual pan/tilt/zoom), text and logo display, display of event/action symbols, meter display (bar chart or diagram), temperature control windows
Power Consumption	Typically 1.5 W per Thermal Sensor Module
Operating Conditions	IP66 (DIN EN 60529) -30 to +60°C/-22 to 140°F (DIN EN 50155)
Dimensions	Total length: 78 mm/3.07 in, max. Ø: 63 mm/2.48 in

Thermal Sensor Module	
Materials	Module housing: Aluminum, black anodized; Pressure plate: Stainless steel V2A
Weight	< 330 g (one Thermal Sensor Module without sensor cable)

S15D with Thermal Sensor Module	
Image Formats (per sensor)	Standard formats like Full HD, VGA, etc. up to 2048 x 1536 (QXGA) and custom formats
Alarm/Events	Video Motion detection, MxActivitySensor, external signals, shock detector, notification via e-mail, FTP, pre- and post-alarm images
Operating Conditions	IP65 (DIN EN 60529) -30 to +60°C/-22 to 140°F (DIN EN 50155)
Power Consumption	Depending on sensor modules used: <ul style="list-style-type: none"> 1x thermal, 1x optical: typ. 6.5 W (7.5 W short-term possible) 2x thermal: typ. 7 W (8 W short-term possible) 1x thermal: typ. 5.5 W (6.5 W short-term possible)
Max. Power Consumption of Attached Extension Modules	USB only: ≤ 1 W MxBus only: ≤ 1 W USB and MxBus: ≤ 2 W
Power Supply	Power-over-Ethernet (IEEE 802.3af); PoE Class 3 required

Innovations – Made in Germany

The German company MOBOTIX AG is known as the leading pioneer in network camera technology and its decentralized concept has made high-resolution video systems cost-efficient.

MOBOTIX AG • Security-Vision-Systems • D-67722 Langmeil • Phone: +49 6302 9816-103 • Fax: +49 6302 9816-190 • sales@mobotix.com