

# AC-F/G4x Family

**Outdoor Backlit**

**Standalone Controllers**

Installation and Programming Manual

**Models:**

AC-F43

AC-F44

AC-G43

AC-G44



AC-F4x



AC-G4x

**ROSSLARE**  
SECURITY PRODUCTS

## **Copyright © 2014 by Rosslare. All rights reserved.**

This manual and the information contained herein are proprietary to ROSSLARE ENTERPRISES LIMITED and/or its related companies and/or subsidiaries' (hereafter: "ROSSLARE"). Only ROSSLARE and its customers have the right to use the information.

No part of this manual may be re-produced or transmitted in any form or by any means, electronic or mechanical, for any purpose, without the express written permission of ROSSLARE.

ROSSLARE owns patents and patent applications, trademarks, copyrights, or other intellectual property rights covering the subject matter in this manual.

TEXTS, IMAGES, AND ILLUSTRATIONS INCLUDING THEIR ARRANGEMENT IN THIS DOCUMENT ARE SUBJECT TO THE PROTECTION OF COPYRIGHT LAWS AND OTHER LEGAL RIGHTS WORLDWIDE. THEIR USE, REPRODUCTION, AND TRANSMITTAL TO THIRD PARTIES WITHOUT EXPRESS WRITTEN PERMISSION MAY RESULT IN LEGAL PROCEEDINGS.

The furnishing of this manual to any party does not give that party or any third party any license to these patents, trademarks, copyrights or other intellectual property rights, except as expressly provided in any written agreement of ROSSLARE.

ROSSLARE reserves the right to revise and change this document at any time, without being obliged to announce such revisions or changes beforehand or after the fact.

# Table of Contents

<b>1. Introduction .....</b>	<b>9</b>
1.1 Controller Types.....	9
1.2 Key Features .....	9
1.3 Box Content .....	10
1.4 Ancillary Equipment .....	11
1.5 Front Panel Description.....	11
<b>2. Technical Specifications .....</b>	<b>13</b>
<b>3. Installation .....</b>	<b>14</b>
3.1 Mounting Instructions .....	14
3.2 Wiring Instructions .....	15
<b>4. Operation .....</b>	<b>19</b>
4.1 Modes of Operation .....	19
4.1.1 Normal Mode (Default).....	19
4.1.2 Secure Mode .....	19
4.1.3 Bypass Mode .....	19
4.2 User Levels.....	20
4.3 Switching Operational Modes .....	21
4.3.1 From Normal to Secure Mode.....	21
4.3.2 From Secure to Normal Mode.....	21
4.3.3 From Normal to Bypass Mode.....	22
4.3.4 From Bypass to Normal Mode.....	22
4.4 Special Operational Features .....	22
4.4.1 Auxiliary Input & Output.....	23
4.4.2 REX Button .....	23

## Table of Contents

---

4.4.3	Tamper Feature .....	23
4.4.4	Lockout Feature (Keypad/Card Tamper) .....	24
4.4.5	BL-D40 External Sounder .....	24
<b>5.</b>	<b>Programming .....</b>	<b>25</b>
5.1	Introduction .....	25
5.1.1	Entering the Programming Mode .....	27
5.1.2	Exiting the Programming Mode .....	27
5.2	Changing the Open Code .....	28
5.3	Changing the Auxiliary Code .....	29
5.4	Changing the Programming Code .....	30
5.5	Changing the Normal/Secure Code .....	30
5.6	Changing the Normal/Bypass Code .....	31
5.7	Setting Fail Safe/Secure Operation .....	32
5.8	Setting Auxiliary Modes .....	33
5.8.1	General .....	33
5.8.2	Detailed Reference Guide .....	36
5.9	Setting the Lockout Feature .....	40
5.10	Backlight and LED Behavior .....	41
5.11	Enrolling Codes .....	42
5.11.1	Primary Codes Definition .....	42
5.11.2	Secondary Codes Definition .....	42
5.11.3	Primary and Secondary Codes Enrolling Methods .....	42
5.11.4	Standard Method for Codes Enrolling .....	43
5.11.5	Search Method for Codes Enrolling .....	44
5.12	Deleting Codes .....	45
5.12.1	Standard Method for Deleting Codes .....	45
5.12.2	Search Method for Deleting Codes .....	46
5.13	Relay Codes Assignment .....	46

## Table of Contents

5.13.1	Relay Code Assignment using Standard Method .....	47
5.13.2	Relay Code Assignment using Search Method .....	48
5.14	Changing PIN Code Length/Factory Default Settings .....	49
5.15	Replacing a Programming Code .....	50
5.16	Replacing a Normal/Secure Code .....	50
<b>A.</b>	<b>Limited Warranty .....</b>	<b>51</b>

# List of Figures

Figure 1: Front Panel of AC-F4x Series .....	11
Figure 2: Front Panel of AC-G4x Series .....	12
Figure 3: Drilling Holes Identification .....	14
Figure 4: Wiring Diagram for Lock Strike Relay & REX.....	16
Figure 5: Wiring Diagram for Auxiliary Input & Output .....	17
Figure 6: Wiring Diagram for the BL-D40 External Sounder .....	18

## List of Tables

Table 1: Wiring Color Guide .....	15
Table 2: Programming Menus.....	26
Table 3: Quick Reference Guide for Auxiliary Mode Setting.....	35

# Notice and Disclaimer

This manual's sole purpose is to assist installers and/or users in the safe and efficient installation and usage of the system and/or product, and/or software described herein.

**BEFORE ATTEMPTING TO INSTALL AND/OR USE THE SYSTEM, THE INSTALLER AND THE USER MUST READ THIS MANUAL AND BECOME FAMILIAR WITH ALL SAFETY REQUIREMENTS AND OPERATING PROCEDURES.**

- The system must not be used for purposes other than those for which it was designed.
- The use of the software associated with the system and/or product, if applicable, is subject to the terms of the license provided as part of the purchase documents.
- ROSSLARE exclusive warranty and liability is limited to the warranty and liability statement provided in an appendix at the end of this document.
- This manual describes the maximum configuration of the system with the maximum number of functions, including future options. Therefore, not all functions described in this manual may be available in the specific system and/or product configuration you purchased.
- Incorrect operation or installation, or failure of the user to effectively maintain the system, relieves the manufacturer (and seller) from all or any responsibility for consequent noncompliance, damage, or injury.
- The text, images and graphics contained in the manual are for the purpose of illustration and reference only.
- All data contained herein subject to change without prior notice.
- In no event shall manufacturer be liable for any special, direct, indirect, incidental, consequential, exemplary or punitive damages (including, without limitation, any and all damages from business interruption, loss of profits or revenue, cost of capital or loss of use of any property or capital or injury).
- All graphics in this manual are for reference only, some deviation between the image(s) and the actual product may occur.
- All wiring diagrams are intended for reference only, the photograph or graphic of the PCB(s) are intended for clearer illustration and understanding of the product and may differ from the actual PCB(s).

# 1. Introduction

The AC-F4x series and AC-G4x series access control units are waterproof standalone controllers. All the units are suitable for both indoor and outdoor mounting. The unit(s) accepts up to 500 users and allows entry via a personal identification number (PIN) and/or by presenting a proximity card.

## 1.1 Controller Types

The different types of control units described in this manual are:

- AC-F43 – PIN only
- AC-F44 – PIN and proximity card
- AC-G43 – Mullion-Box PIN only
- AC-G44 – Mullion-Box PIN and proximity card

	<b>Relay Current</b>	<b>Backlight</b>	<b>Keypad Type</b>	<b>Proximity</b>
<b>AC-F43</b>	2 A	✓	3X4 Standard	✗
<b>AC-F44</b>	2 A	✓	3X4 Standard	✓
<b>AC-G43</b>	2 A	✓	2X6 Mullion	✗
<b>AC-G44</b>	2 A	✓	2X6 Mullion	✓

## 1.2 Key Features

- 500 users
- Water resistant
- Programmable Backlight and active LED control
- Three user levels: normal; secure; master
- Three modes of operation: normal; bypass; secure
- Integrated keypad for PIN entry
- Integrated proximity card reader (F44 and G44 only)

## Introduction

---

- Selectable PIN code length up to 8 digits
- Auxiliary input and auxiliary output
- Ten auxiliary modes including: door ajar; forced door; shunt; door monitor; normal / secure; LED control
- Input for Request to Exit (REX) button
- Code search feature for easy maintenance of user codes
- Internal buzzer
- Vandal proof screw (special tool supplied)
- Two tri-color LED indicators for status / programming Interface
- Built-in case and back tamper protection
- Lockout feature on wrong entries (Keypad / Card Tamper)
- Bell, chime, siren and strobe features available with BL-D40
- Programmable siren time (with BL-D40)
- Programmable lock strike release time.
- Supplied with mounting template for easy installation

### 1.3 Box Content

Before beginning, verify that all of the following is in the box. If anything is missing please report the discrepancy to your nearest Rosslare Office.

- One unit
- One drilling template (label/sticker)
- One security spline key
- One security hex screw
- Four mounting screws and wall plugs

## 1.4 Ancillary Equipment

The following ancillary equipment may be required to complete your installation:

- Electric Lock Strike Mechanism – fail safe (power to lock) or fail secure (power to open).
- Power supply with backup battery – 12 to 24 VDC (from a regulated power supply) or 16 to 24 VAC (from a transformer).
- Request to Exit (REX) Button (optional) – normally open type; switch is closed when pressed.
- BL-D40 External Sounder (optional) – provides siren, bell, and chime.
- Magnetic contact (optional) – installed for door monitor capabilities.

Other Rosslare accessories can be found at Rosslare's Website:

[www.rosslaresecurity.com](http://www.rosslaresecurity.com)

## 1.5 Front Panel Description

Figure 1 and Figure 2 show the controls and indicators of all controller versions.

**Figure 1: Front Panel of AC-F4x Series**

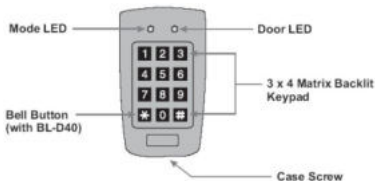

**Figure 2: Front Panel of AC-G4x Series**

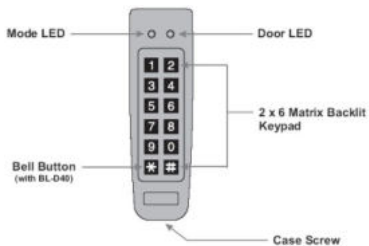

## 2. Technical Specifications

		<b>AC-F43</b>	<b>AC-F44</b>	<b>AC-G43</b>	<b>AC-G44</b>
<b>Input Voltage</b>	<b>VDC</b>	12 to 24 VDC			
	<b>VAC</b>	16 to 24 VAC			
<b>Maximum Input Current (12 VDC)</b>		125 mA	160 mA	125 mA	160 mA
<b>Standby Input Current (12 VDC)</b>		75 mA	95 mA	75 mA	95 mA
<b>Maximum Relay Current</b>		2 A			
<b>REX Input</b>		Normally Open (dry contact)			
<b>Aux. Input</b>		Normally Open (dry contact)			
<b>Max. Proximity Read Range*</b>		N/A	75 mm (3.0 in.)	N/A	80 mm (3.2 in.)
<b>Proximity Modulation</b>		N/A	ASK at 125 kHz	N/A	ASK at 125 kHz
<b>Proximity Card Compatibility</b>		N/A	26 Bits EM cards	N/A	26 Bits EM cards
<b>LED Indicators</b>		Two 3-colored LED (Mode and Door)			
<b>Operating Temp. Range</b>		-30°C to 65°C (-22°F to 150°F)			
<b>Operating Humidity Range</b>		0 to 95% (non-condensing)			
<b>Outdoor Usage</b>		Weather resistant, meets IP65, epoxy-potted			
<b>Size (H x W x D)</b>		120.9 x 71.1 x 29.7 mm (4.7 x 2.8 x 1.2 in.)		135.4 x 44.2 x 28.5 mm (5.3 x 1.7 x 1.1 in.)	
<b>Weight</b>		244 g (8.6 oz)		178 g (6.3 oz)	

\* Measured using a Rosslare proximity card or equivalent. Range also depends on electrical environment and proximity to metal.

### 3. Installation



Installation of an RFID reader adjacent to metallic surfaces might alter the reader's specifications. To diminish this interference, use a plastic spacer when mounting the reader.

#### 3.1 Mounting Instructions

Prior to starting, select the location where the controller unit is to be mounted.

##### *To install the controller:*

1. Open the controller by loosening and removing the case security screw at the bottom using the security spline key.
2. Depending on the type of installation, gang box or panel mount, drill the respective holes in the rear cover (Figure 3).

**Figure 3: Drilling Holes Identification**

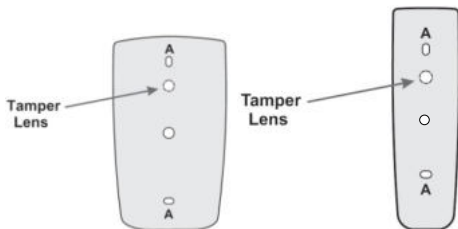

The central hole is for routing the wiring to the controller.

3. Use the provided drilling template to accurately locate and drill the required holes in the wall or panel.
4. Use the hardware provided to mount the back plate on the wall or on a gang box. Be sure to route the wiring via the large center hole in the back plate. Check for level.
5. Wire the controller's pre-wired cable as described in Section 3.2.

- Once wired, replace the controller back onto its back plate and secure using the tamper-proof screw and special tool, supplied with the hardware.

### 3.2 Wiring Instructions

The controllers are provided with a one-meter, pre-wired, 10-conductor 18-AWG cable.

#### *To wire the controller:*

- Cut and strip the conductors to the necessary length.
- Splice the controller pigtail wires to the corresponding ancillary devices and insulate each connection, including unused wires.
- Refer to Table 1 and to the wiring diagrams, depending on the desired application:
  - Wiring the Lock Strike Relay and REX (Figure 4)
  - Wiring for Auxiliary Input and Output (Figure 5)
  - Wiring for the BL-D40 External Sounder (Figure 6)

**Table 1: Wiring Color Guide**

<b>Color</b>	<b>Description</b>
Red	V input
Black	Ground
Green	REX/BL
White	In / Monitor
Purple	Lock: Com
Gray	Lock: N.O.
Brown	Lock: N.C.
Blue	Aux: Com
Yellow	Aux: N.O.
Orange	Aux: N.C.

Figure 4: Wiring Diagram for Lock Strike Relay & REX

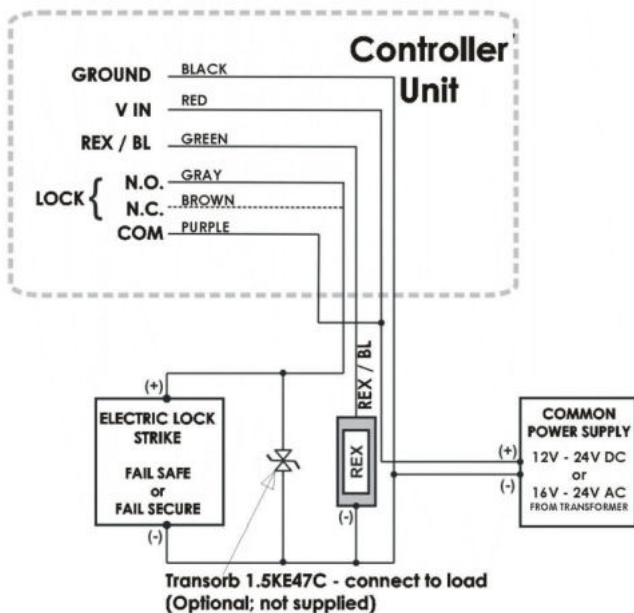

Figure 5: Wiring Diagram for Auxiliary Input &amp; Output

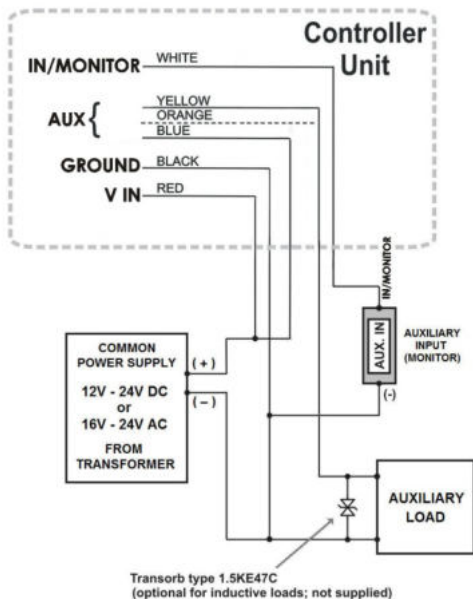
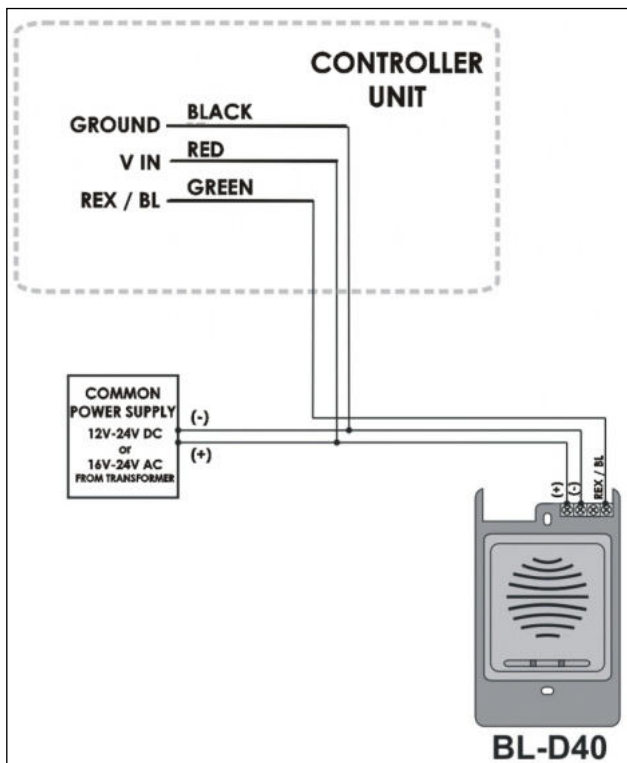

Figure 6: Wiring Diagram for the BL-D40 External Sounder



## 4. Operation



- In the Operation chapter, “code” refers to a PIN code or proximity card depending on the unit you have.
- Memory slots can be a proximity card or PIN code depending on the unit you have.

### 4.1 Modes of Operation

The control units have three modes of operation. These are indicated by the color of the Mode indicator:

#### 4.1.1 Normal Mode (Default)

The mode indicator is green.

In Normal mode, the door is locked until a valid primary code is presented to the controller.

The controller can only be programmed in Normal mode.

#### 4.1.2 Secure Mode

The mode indicator is red.

Only secure and master users can access the premises in Secure mode.

A secure user must enter a primary and secondary code to gain entry. Once the primary code has been entered, the Door indicator flashes green for 10 seconds. During this time, the secondary code must be entered. A master user only needs to enter his code to gain entry.

#### 4.1.3 Bypass Mode

The mode indicator is orange.

In Bypass mode, access to the premises is dependent on the Lock Strike relays; that is, if the relay is programmed for failsafe operation or fail-secure operation.

When the Lock Strike relay is programmed for fail secure operation, the door is locked until \* is pressed.

When the Lock Strike relay is programmed for failsafe operation, the door is constantly unlocked.

In case of power failure, once the power is restored, the controller returns to Normal mode for security reasons.

### 4.2 User Levels

The AC-F4x and AC-G4x series access control units accept up to 500 users and provide entry via the use of codes. Each user is allocated two memory slots: Memory Slot 1 (primary code) and Memory Slot 2 (secondary code).

The way in which the two memory slots are programmed, determines a user's access level and also establishes access is granted for each of the three modes of operation.

There are three user levels:

- Normal User  
A normal user only has a primary code and is granted access only when the controller is in its Normal or Bypass mode.
- Secure User  
A secure user must have a primary and secondary code assigned, and the two codes must not be the same. The secure user can gain access in any mode of operation. In Normal mode, the secure user must use the primary code to gain entry. In Secure mode, the secure user must first enter the primary and then the secondary code, in order to gain entry.
- Master User  
A master user must have identical primary and secondary codes assigned. The codes are entered with the same proximity card or the same PIN. The master user can gain access during any mode of operation by entering their code only once.

## 4.3 Switching Operational Modes

The three modes of operation defined above, can be changed through a few steps.

### 4.3.1 From Normal to Secure Mode

The default factory setting for the normal/secure code is 3838.

***To change from Normal to Secure mode:***

1. Enter the Normal/Secure code.

Mode   Door  
Green

The Mode indicator flashes red.

Mode   Door  
Red

2. Press # to confirm the mode change.

The Mode indicator is red.

Mode   Door  
Red

The auxiliary input of the controller can also be used to switch the mode of operation from secure to normal and vice versa, if the auxiliary input is selected it de-activates the Normal/Secure mode code (see Section 5.8).

### 4.3.2 From Secure to Normal Mode

The default factory setting for the normal/secure code is 3838.

***To change from Secure to Normal mode:***

1. Enter the Normal/Secure code.

Mode   Door  
Red

The Mode indicator flashes green.

Mode   Door  
Green

2. Press # to confirm the mode change.

The Mode indicator turns green.

Mode   Door  
Green

The auxiliary input of the controller can also be used to switch the mode of operation from secure to normal and vice versa, if the

## Operation

---

auxiliary input is selected it de-activates the Norma/Secure mode code (see Section 5.8).

### 4.3.3 From Normal to Bypass Mode

By default, there is no Normal/Bypass code. The Normal/Bypass code must first be programmed to use this function (see Section 5.6 to create/modify the Normal/Bypass code).

#### *To change from Normal to Bypass mode:*

1. Enter the Normal/Bypass code.



The Mode indicator flashes orange.



2. Press # to confirm the mode change.

The Mode indicator turns orange.



### 4.3.4 From Bypass to Normal Mode

#### *To change from Bypass to Normal mode:*

1. Enter the Normal/Bypass code.



The Mode indicator flashes green.



2. Press # to confirm the mode change.

The Mode indicator turns green.



## 4.4 Special Operational Features

Some installation-specific features are exercised, as required by the system. These features are implemented as shown in Figure 5 and Figure 6.

### 4.4.1 Auxiliary Input & Output

For optimum usability in different applications, the controller's auxiliary input and output can be configured in 10 different modes of operation (see Section 5.8).

### 4.4.2 REX Button

The REX pushbutton is located within the premises and is used to open the door from the inside. It is usually located in a convenient location, such as next to the door or at a receptionist's desk. The door chime in the BL-D40 (if enabled) does not sound when the REX pushbutton is used to open the door.

The function of the REX pushbutton depends on the Lock Strike relay, whether it is programmed for failsafe or for fail secure operation.

- **Fail Secure Operation**

From the moment the REX pushbutton is pressed, the door is unlocked until the Lock Strike Release time has elapsed. After this time, the door is locked, even if the REX pushbutton has not been released.

- **Failsafe Operation**

From the moment the REX pushbutton is pressed, the door is unlocked until the REX pushbutton is released. In this case, the Lock Strike relay only begins its countdown once the REX pushbutton is released. This feature is designed to keep the door open, when used in conjunction with fire systems.

### 4.4.3 Tamper Feature

If the controller is forcibly opened or the controller is removed from the wall, a tamper event is triggered. A tamper signal is sent to the BL-D40.

If the BL-D40 External Sounder receives a tamper event signal, it activates a tamper output and a strobe light. The Siren time can be easily programmed in the controller from 0 to 9 minutes.

The tamper event can activate the auxiliary output if the controller is in Auxiliary Mode 3 (see Table 3).

### 4.4.4 Lockout Feature (Keypad/Card Tamper)

If the controller is presented with wrong codes, (PIN or Card) consecutively several times the unit goes into lockout mode.

When a lockout occurs, the controller keypad and reader are deactivated so no codes can be entered until the set lockout period expires.

During Lockout, Mode LED is Off, Door LED flashes Red, and the controller beeps every two seconds.

Refer to programming menu 6 for detailed programming of this feature.

### 4.4.5 BL-D40 External Sounder

The BL-D40 External Sounder is designed for indoor use only and installed within the secured premises. The Sounder can be powered by a 12 to 24 VDC power supply or by a 16VAC transformer. The BL-D40 is capable of emitting four different types of audible and visual alerts: bell, chime, siren and strobe light.

- The bell sounds when the controller's bell button is pressed.
- The door chime can be programmed to sound whenever a valid code is entered as well as for a door held open alert.
- The siren can be programmed to sound when the controller is tampered with (opened or removed from the wall). The length of the siren can also be programmed in the controller.

The controller communicates with the BL-D40 via a Rosslare proprietary protocol. If the BL-D40 receives an unrecognized code over its communication line or communications between the controller and the BL-D40 are severed, the strobe flashes repeatedly, until the communication problem has been resolved.

## 5. Programming



- In the Programming chapter, “code” refers to a PIN code or proximity card depending on the unit you have.
- When entering a PIN or presenting a proximity card is mentioned, the meaning may vary between units.

### 5.1 Introduction

Programming an access control unit is done solely via the unit’s keypad-driven Programming Menu System. To reach the Programming Menu System, the controller must first be placed into Programming Mode (see Section 5.1.1).

During the manufacturing process, certain codes and settings are pre-programmed. These settings are the called default factory settings.

## Programming

Table 2 shows all the programming menus, with default factory codes and settings.

**Table 2: Programming Menus**

Menu No.	Description	Default				Section
		4 Digits	5 Digits	6 Digits	4-8 Digits	
1	Change Open code	2580	25802	258025	25802580	5.2
2	Change Auxiliary code	0852	08520	085208	08520852	5.3
3	Change Program code	1234	12341	123412	12341234	5.4
4	Change Normal/Secure code	3838	38383	383838	38383838	5.5
5	Change Normal/Bypass code	-				5.6
6	Change Door Release time	0004				5.7
6	Define auxiliary inputs/outputs	2004				5.8
6	Set Lockout Feature	4000				5.9
6	Backlight and LED Behavior	5100				5.10
7	Enroll proximity cards, PIN or both	-				5.11
8	Delete proximity cards or PIN	-				5.12
9	Code assignment with strike/auxiliary	-				5.13
0	Return to factory defaults/Change PIN code Length	-				5.14

### 5.1.1 Entering the Programming Mode



- The controller must be in Normal mode to enter the programming mode.
- The factory default 4-digit programming code is 1234.
- If a Programming code is not entered within 5 seconds, the controller returns to Normal mode.

#### *To enter Programming mode:*

1. Press # twice within 0.5 seconds.

Mode indicator turns off and the Door indicator turns red

Mode   Door  
Red

2. Enter your programming code.

If the programming code is valid, the door Indicator turns green and the controller enters the Programming mode.

Mode   Door  
Green

### 5.1.2 Exiting the Programming Mode



- Wrong entries may reset the controller back to Normal mode.
- If no key is pressed for 1 minute, while in programming mode, the controller exits Programming mode and returns to Normal mode.

#### *To exit Programming mode:*

1. Press # twice within 0.5 seconds.

- You hear three beeps.
- The door indicator turns off.
- The mode indicator turns green.

Mode   Door  
Green

The above indicates that the controller has returned to Normal mode.



While enrolling, deleting users, or while in code assignment mode, press # twice to exit Programming mode.

### 5.2 Changing the Open Code

The open code is mainly used as a method to quickly test the Lock Strike relay during installation.

The factory 4-digit default setting for the open code is 2580.

For security reasons, when the first user is added to the controller or the auxiliary code is changed, the default open code is automatically deleted; non-default codes are not be erased automatically.



Note

- Open code does not function in Secure mode.
- For wrong entries, you hear a long beep and the controller returns to Normal mode.
- Code 0000 erases and deactivate the open code.

#### *To change the Open code:*

1. Enter Programming mode.

Mode   Door  
Green

2. Press **1** to enter Menu 1.

The Mode indicator turns red.

Mode   Door  
Red Green

3. Enter the new code you wish to set as open code.

You hear three beeps.

The system returns to Normal mode.

Mode   Door  
Green

### 5.3 Changing the Auxiliary Code

The auxiliary code is mainly used as a method to quickly test the Auxiliary relay during installation. The default 4-digit factory setting for the auxiliary code is 0852.

For security reasons, when the first user is added to the controller or the open code is changed, the default auxiliary code is automatically deleted; non-default codes are not be erased automatically.



- Auxiliary code does not function in Secure mode.
- Auxiliary code only works when the auxiliary mode is 0, 1, 8 or 9.
- Wrong entries: You hear a long beep and the controller returns to Normal mode.
- Code 0000 erases and deactivates the auxiliary code.

#### *To change the Auxiliary code:*

1. Enter Programming mode.

Mode   Door  
Green

2. Press **2** to enter Menu 2.

The Mode indicator turns orange.

Mode   Door  
Orange Green

3. Enter a new Auxiliary code.

You hear three beeps.

The system returns to Normal mode.

Mode   Door  
Green

### 5.4 Changing the Programming Code



- The code 0000 is not valid; thus, the programming code cannot be erased.
- For wrong entries, you hear a long beep and the controller returns to Normal mode.

#### *To change the Programming code:*

1. Enter Programming mode.

Mode   Door  
Green

2. Press **3** to enter Menu 3.

The Mode indicator turns green.

Mode   Door  
Green Green

3. Enter a new Programming code.

You hear three beeps.

The system returns to Normal mode.

Mode   Door  
Green

### 5.5 Changing the Normal/Secure Code



- When the auxiliary mode is 1, 2, 3 or 4, the auxiliary input takes priority over the Normal/Secure code.
- For wrong entries, you hear a long beep and the controller returns to Normal mode.
- Code 0000 erases and deactivates the normal/secure code.

#### *To change the Normal/Secure code:*

1. Enter Programming mode.

Mode   Door  
Green

2. Press **4** to enter Menu 4.

The Mode indicator flashes red.

Mode   Door  
Red Green

3. Enter the new Normal/Secure code.

You hear three beeps.

Mode  Green  Door

The system returns to Normal mode.

## 5.6 Changing the Normal/Bypass Code

The Normal/Bypass code is also used to turn the door chime off and on. Chime only functions with the BL-D40 External Sounder.



- The chime is only heard when the Lock Strike relay is activated by a valid code entry.
- Wrong entries: You hear a long beep and the controller returns to Normal mode.
- Code 0000 erases and deactivates the Normal/Bypass code.

### *To change the Normal/Bypass code:*

1. Enter Programming mode.

Mode   Door  
Green

2. Press **5** to enter Menu 5.

The Mode indicator flashes orange.

Mode   Door  
Orange Green

There are four different ways to program the Normal/Bypass code and door chime:

- Disable both Bypass Code and the door chime – enter the code **0000**.
- Disable Bypass Code and enable the door chime – enter the code **0001**.
- Enable Bypass Code and disable the door chime – enter any code ending with 0.
- Enable Bypass Code and enable the door chime – enter a code not ending with 0.

You hear three beeps.

The system returns to Normal mode.

Mode   Door  
Green

### 5.7 Setting Fail Safe/Secure Operation

In this paragraph, the failsafe/fail secure operation of the door lock and the Door Lock Strike Release time are set. Setting the sounding period for the siren feature requires a BL-D40 External Sounder.

*To set the failsafe/secure operation:*

1. Enter Programming mode.

Mode   Door  
Green

2. Press **6** to enter Menu 6.

The Mode indicator flashes green.

Mode   Door  
Green Green

3. Construct a code using the following instructions:

#### First Digit

For fail secure operation, the first digit is set to **0**.

For fail safe operation, the first digit is set to **1**.

#### Second Digit

Siren time, enter any number from 0 to 9 (minutes).

#### Third and Fourth Digits

The Lock Strike is to be released after the number of seconds entered (1 to 99).

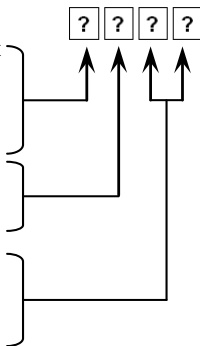

For example **0 5 1 2** means: fail secure operation (0), with 5 minutes Siren time (5) and a 12-second Lock Strike Release time (12).

You hear three beeps.  
The system returns to Normal mode.

Mode   Door  
Green

## 5.8 Setting Auxiliary Modes

### 5.8.1 General

The default auxiliary setting is 2004.

*To set Auxiliary modes:*

1. Enter Programming mode.

Mode   Door  
Green

2. Press **6** to enter Menu 6.

The Mode indicator flashes green.

Mode   Door  
Green Green

3. Construct a code using the following instructions:

Table 3 provides a quick reference listing for the auxiliary modes and settings)

Auxiliary Mode  
Auxiliary Setting

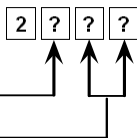

Note

Auxiliary Relay activation is subject to the user's Auxiliary code assignment (excluding Shunt, which is activated by all users). For more details, see Section 5.13.

### Auxiliary Mode

In addition to the Lock Strike relay and the Lock Strike REX, the controller features an auxiliary output relay and an auxiliary input, whose function is established by the auxiliary mode selection (0 thru 9).

The auxiliary mode also determines if the auxiliary output relay is set for failsafe or for fail secure operation.

For a more detailed explanation on each auxiliary mode, see Table 3 below.

### Auxiliary Settings

Each of the auxiliary modes has a two-digit setting which affects the operation of the related relay(s).

You hear three beeps.

The system returns to Normal mode.

Mode   Door  
Green

**Table 3: Quick Reference Guide for Auxiliary Mode Setting**

<b>Auxiliary Mode</b>	<b>Auxiliary Input Function</b>	<b>Auxiliary Output Activated by</b>	<b>Auxiliary Relay</b>	<b>Auxiliary Settings (in seconds)</b>
0	AUX REX	Valid code or AUX REX	N.O.	01 to 99 Aux. Relay Release Time 00 Aux. relay toggle
1	Normal/Secure switch	Valid code	N.O.	01 to 99 Aux. Relay Release Time 00 Aux. relay toggle
2	Normal/Secure switch	Star button (*)	N.O.	01 to 99 Aux. Relay Release Time 00 Aux. relay toggle
3	Normal/Secure switch	Tamper event	N.C.	01 to 99 Aux. Relay Release Time 00 Aux. relay tamper activated
4	Normal/Secure switch	Direct shunt	N.O.	01 to 99 Shunt time
5	Door Monitor	Shunt	N.C.	01 to 99 maximum Shunt time
6	Door Monitor	Forced door	N.C.	01 to 99 Forced delay
7	Door Monitor	Door ajar	N.C.	01 to 99 Ajar delay
8	LED control – Green	Valid code	N.O.	01 to 99 Aux. Relay Release time 00 Aux. relay toggle
9	LED control – Red	Valid code	N.O.	01 to 99 Aux. Relay Release time 00 Aux. relay toggle

### 5.8.2 Detailed Reference Guide

The following subsections provide brief descriptions of each auxiliary mode. To implement the features of each mode, see Section 5.8.1.

#### 5.8.2.1 Auxiliary Mode 0

**Auxiliary input function:** Activates the auxiliary output

**Auxiliary output activated by:** Valid user code, Auxiliary code, Auxiliary input

For example, in Auxiliary Mode 0, the controller can function as a two-door controller. The auxiliary relay is to be attached to the lock on the second door. The auxiliary setting defines the Door Open time for the second door. The auxiliary input is to be attached to the REX pushbutton for the second door. Door Monitor input feature for the second door is not enabled when using this mode.

#### 5.8.2.2 Auxiliary Mode 1

**Auxiliary input function:** Toggles Normal/Secure modes

**Auxiliary output activated by:** Valid user code, Auxiliary code

For example, in Auxiliary Mode 1, the controller can function as a two-door controller. The auxiliary relay is to be attached to the lock on the second door. REX feature for the second door is not enabled when using this mode.

The auxiliary setting defines the Door Open time for the second door. The auxiliary input can switch the mode of operation of the controller between Normal and Secure mode. By connecting a switch timer or alarm system output to the auxiliary input, the controller can be automatically switched from Normal mode (during office hours) to Secure mode (after office hours).

#### 5.8.2.3 Auxiliary Mode 2

**Auxiliary input function:** Toggles Normal/Secure modes

**Auxiliary output activated by:** Star Button (\*)

For example, in Auxiliary Mode 2, the auxiliary relay can function as a general purpose time switch that can be activated when \* is pressed. The auxiliary setting establishes for how long the auxiliary relay is to

be activated. The auxiliary input can switch the mode of operation of the controller between Normal and Secure mode. By connecting a switch timer or alarm system output to the auxiliary input, the controller can be automatically switched from Normal mode (during office hours) to Secure mode (after office hours).

#### 5.8.2.4 Auxiliary Mode 3

**Auxiliary input function:** Toggles Normal/Secure modes

**Auxiliary output activated by:** Alarms

For example, in Auxiliary Mode 3, the auxiliary output is activated if the controller is tampered; that is, if the case is forcibly opened or removed from the wall. The auxiliary input can switch the mode of operation of the controller between Normal and Secure mode. By connecting a switch timer or alarm system output to the auxiliary input, the controller can be automatically switched from Normal mode (during office hours) to Secure mode (after office hours).

#### 5.8.2.5 Auxiliary Mode 4

**Auxiliary input function:** Toggles Normal/Secure modes

**Auxiliary output activated by:** direct shunt (explanation below)

For example, in Auxiliary Mode 4, the controller is capable of bypassing an alarm zone by shunting an alarm system's door sensor. The auxiliary output is to be wired in parallel to the door sensor output. When in use, the auxiliary output is normally open and the door sensor functions normally. When a valid code is entered, the auxiliary relay shunts the door sensor for the duration of the Shunt time, as defined by the auxiliary setting. If the door is left open longer than the Shunt time, an alarm is triggered.

#### 5.8.2.6 Auxiliary Mode 5

**Auxiliary input function:** Door Monitor

**Auxiliary output activated by:** Shunt (explanation below)

For example, in Auxiliary Mode 5, the controller is capable of shunting an alarm system. In this mode, the auxiliary input is to be wired to the magnetic contact switch on the door. The auxiliary relay is wired to the alarm system. Without a valid code entered, the auxiliary relay

matches the condition of the magnetic contact switch; if the door opens, the auxiliary relay opens; if the door closes, the auxiliary relay closes. When a valid code is entered, a countdown for maximum Shunt time, as defined by the auxiliary setting, begins; if the door is not closed before the maximum Shunt time, the alarm is triggered.

### 5.8.2.7 Auxiliary Mode 6

**Auxiliary input function:** Door Monitor

**Auxiliary output activated by:** Forced entry

For example, in auxiliary mode 6, the controller can trigger the auxiliary relay if the door has been forced. If the Siren Settings is enabled, the siren is activated.

In this mode, the auxiliary input functions as a door monitor switch and is wired to the magnetic contact switch on the door. The auxiliary relay is to be wired to the alarm system. If the door is forced open, the controller waits for the period of the Forced Door Delay time to elapse and then it activates the auxiliary relay. The auxiliary setting sets the forced door delay period.

### 5.8.2.8 Auxiliary Mode 7

**Auxiliary input function:** Door Monitor

**Auxiliary output activated by:** Door Ajar (door held open)

For example, in Auxiliary Mode 7, the controller can trigger the auxiliary relay, if it detects that the door has been held open (ajar) too long. In this mode the auxiliary input functions as a door monitor switch and is wired to the magnetic contact switch on the door. The auxiliary relay is to be wired to the alarm system. If the door is opened, the controller waits for the Door Ajar Delay time to elapse and if the door does not close prior to the end of this period, the controller activates the auxiliary relay. The auxiliary setting defines the Door Ajar time.

If the BL-D40 External Sounder is connected in the system and a door-ajar event occurs, the BL-D40 chimes every few seconds for 1 minute or until the door is closed.

### 5.8.2.9 Auxiliary Mode 8

**Auxiliary input function:** Green LED control

**Auxiliary output activated by:** Valid user code, Auxiliary code

For example, in Auxiliary Mode 8, the controller can function as a two-door controller and also provide indicator functionality control. The auxiliary relay is connected to the lock on the second door. The auxiliary setting defines the Door Open time for the second door. The auxiliary input is used to control the Door indicator. If the auxiliary input is open, the indicator flashes green; if the auxiliary input is closed, the Door indicator flashes red.



This mode takes control of the Door indicator LED.

The indicator LED is not lit when:

- A valid code is entered
- While in Secure mode, when waiting for a secondary code

### 5.8.2.10 Auxiliary Mode 9

**Auxiliary input function:** Red LED control

**Auxiliary output activated by:** Valid user code, Auxiliary code

For example, in Auxiliary Mode 9, the controller can function as a two-door controller and also provide indicator functionality control. The auxiliary relay is connected to the lock on the second door. The auxiliary setting defines the Door Open time for the second door. The auxiliary input is used to control the indicator. If the auxiliary input is open, the Door indicator flashes red; if the auxiliary input is closed, the Door indicator flashes green.



This mode takes control of the Door indicator LED.

The indicator LED is not lit when:

- A valid code is entered
- While in Secure mode, when waiting for a secondary code

### 5.9 Setting the Lockout Feature

If the controller is presented with wrong codes, (PIN or Card) consecutively several times the unit goes into lockout mode.

When a lockout occurs, the controller keypad and reader are locked so no codes can be entered until the set lockout period expires.

During Lockout, Mode LED is Off, Door LED flashes Red, and the controller beeps every two seconds.

The default setting for the Lockout Feature is 4000 (Lockout Disabled).



Using the lockout feature is highly recommended, especially when selecting to use short PIN code length (4 or 5 digits).

#### *To define the Lockout feature:*

1. Enter Programming mode.

Mode  Door   
Green

2. Press **6** to enter Menu 6.

The Mode indicator flashes green.

Mode  Door   
Green Green

3. Construct a code using the following instructions:

Set the number of wrong code attempts, which causes a Lockout between 0 and 9 attempts.

Sets the duration of the lockout, between 00 and 99; the value is multiplied by ten, resulting in 0 to 990 seconds.

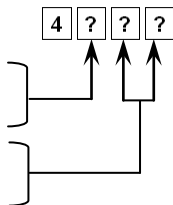

## 5.10 Backlight and LED Behavior



This section is applicable for AC-Q4xHB/SB models only (backlight).

The controller allows you to define the way the unit's Backlight as well as the Mode and Door LEDs work.

### *To define the Backlight and LEDs behavior:*

1. Enter Programming mode.

Mode  Door   
Green Green

2. Press **6** to enter Menu 6.

3. The Mode indicator flashes green.

Mode  Door   
Green Green

4. Construct a code using the following instructions:

The first digit is five indicating the backlight and Led option

The second key can be 0–3 indicating the type of activity

- Option 0 – LED Active/Backlight Off
- Option 1 – LED Active/Backlight On (default)
- Option 2 – LED and Backlight Off, both activated on any key press for 10 seconds.
- Option 3 – LED Active/Backlight Dimmed, backlight activated on any key press for ten seconds.

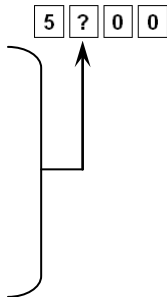

### 5.11 Enrolling Codes

#### 5.11.1 Primary Codes Definition

- Primary codes can only be enrolled to an empty user slot, a slot with no existing primary code in the controller's memory.
- A primary code must be unique; for instance, one user's primary code may not be the same as that of another user.
- Primary codes cannot be the same as system codes, such as: the normal/secure code or the open code.
- Users possessing a primary code can gain entry during Normal and Bypass modes.

#### 5.11.2 Secondary Codes Definition

- Secondary codes can only be enrolled to a user slot that already includes a primary code.
- A Secondary code need not be unique; for instance, one user's Secondary code may be the same as that of another user.
- Secondary codes cannot be the same as any system codes, such as: the normal/secure code or the open code.
- Users possessing secondary codes can gain entry in any mode of operation.
- A Secondary code can be the same as the primary code of any user.

#### 5.11.3 Primary and Secondary Codes Enrolling Methods

There are two methods used to enroll primary and secondary codes: the standard method and the code search method.

- The Standard Method is used when the user slot number, for the user you wish to program, is known. You can program both primary and secondary codes using this method.
- The Code Search Method is mainly used when enrolling a secondary code and the user's slot code is unknown. The code search method functions only if a user's primary code is already enrolled and the secondary code is not.

### 5.11.4 Standard Method for Codes Enrolling

#### *To enroll codes using the Standard method:*

1. Enter Programming mode.

Mode   Door  
Green

2. Press **7** to enter Menu 7.

The Door indicator turns orange.



Mode   Door  
Orange

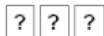

3. Enter the 3-digit user slot number into the memory (from 001 to 500) so as to enroll a primary or secondary code. For example, the user slot 003 represents User No. 3.



4. There are three possibilities:

- If the selected slot has no primary code, the Mode indicator flashes green, indicating that the controller is ready to accept a primary code
 

Mode   Door  
Green Orange
- If the selected slot already has a primary code, but no secondary code, the Mode indicator flashes red, indicating that the controller is ready to accept a secondary code.
 

Mode   Door  
Red Orange
- If the selected slot already has a primary and secondary code, a long beep is heard and the controller returns to Normal mode.

- Enter the code to be assigned as the primary or secondary code for this slot number.

If the code entered is valid, the Mode indicator stops flashing and the controller is ready for the next 3-digit slot number (Step 3) or press **#** to move to the next slot number (Step 4).

If you do not wish to continue enrolling codes, press **#** twice and the controller returns to Normal mode.

### 5.11.5 Search Method for Codes Enrolling

The code search method enables to quickly enroll a secondary code for a user whose primary code is known and whose slot number is unknown.

#### *To enroll codes using the Search method:*

- Enter Programming mode.

Mode   Door  
Green

- Press **7** to enter Menu 7.

The Door indicator turns orange.

Mode   Door  
Orange

- Enter the 3-digit user slot number **000**.

The Door indicator flashes orange.

The controller is now waiting for the primary code of the user

Mode   Door  
Orange

- Enter the primary code belonging to the user who needs a secondary code.

- The Mode indicator flashes red.

Mode   Door  
Red Orange

If the primary code entered is not valid, a long beep sounds and the controller waits for a valid primary code.

- Enter the code to be used as the secondary code.

If the secondary code is valid, the controller beeps three times and returns to Normal mode.

If the secondary code is invalid, the controller produces a long beep and waits for a valid secondary code to be entered.

## 5.12 Deleting Codes

There are two methods to delete primary and secondary codes: a standard method and a search method. When deleting a user slot, both the primary code and the secondary code are erased.



It is recommended that a record be kept of added and deleted users. This makes it easier to keep track of user slots' status (empty or not).

### 5.12.1 Standard Method for Deleting Codes

- Enter Programming mode.

Mode   Door  
Green

- Press **8** to enter Menu 8.

The Mode indicator turns red.

Mode   Door  
Red Orange

The Door indicator turns orange.

- Enter the 3-digit user slot code to be deleted.

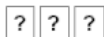













The Mode indicator flashes red, indicating the controller is waiting for a programming code to confirm the deletion.

Mode   Door  
Red Orange

If the user slot is empty, a long beep is heard and the controller returns to Normal mode.

- Enter your programming code to confirm the deletion.  
If the programming code is valid, three beeps are heard and the controller returns to Normal mode.  
If the programming code is invalid, a long beep is heard and the controller returns to Normal mode

### 5.12.2 Search Method for Deleting Codes

- Enter Programming mode.  Mode  Door   
Green
- Press **8** to enter Menu 8.  
The Mode indicator turns red.  Mode  Door   
The Door indicator turns orange. Red Orange
- Enter **000** for user slot.   
The Door indicator flashes orange.  Mode  Door   
The controller is now waiting for the primary code of the user to be deleted. Red Orange
- Enter the primary code to be deleted.  
The Mode indicator flashes red.  Mode  Door   
Red Orange
- Enter your programming code to confirm the deletion.  
If the programming code is valid, three beeps are heard and the controller returns to Normal mode.  
If the programming code is invalid, a long beep is heard and the controller returns to Normal mode

### 5.13 Relay Codes Assignment

When a primary code is enrolled for any user, the user is authorized to activate the Lock Strike relay. However, different user codes may be set to operate the auxiliary relay instead or operate both the Lock

strike and auxiliary relay. Assignment of such codes is achievable for any valid user code entered in the controller.

There are two methods to assign relay codes to users: a standard method and a search method.

## 5.13.1 Relay Code Assignment using Standard Method



### *To assign the relay code using Standard method:*

1. Enter Programming mode.

Mode   Door  
Green

2. Press **9** to enter Menu 9.

The Mode indicator turns green.

Mode   Door  
Green Orange

The Door indicator turns orange

3. Enter the 3-digit user slot for code assignment.

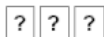



The Mode indicator flashes green.

Mode   Door  
Green Orange

4. Enter the assignment digit for the current user slot:
  - **1** activates the Lock Strike relay only default
  - **2** activates the Auxiliary relay only
  - **3** activates the Lock Strike and Auxiliary relays

If the assignment code is valid, the Mode indicator stops flashing.

Mode   Door  
Green Orange

The controller is now waiting for another slot number.

5. Press **#** to move to the next slot or enter a new slot number.
6. If you do not wish to continue, press **#** twice and the controller returns to Normal mode.

### 5.13.2 Relay Code Assignment using Search Method



*To assign the relay code using Search method:*

1. Enter Programming mode.

Mode   Door  
Green

2. Press **9** to enter Menu 9.

The Mode indicator turns green.

Mode   Door  
Green Orange

The Door indicator turns orange

3. Enter **000** for user slot access.

The Door indicator flashes orange.

Mode   Door  
Green Orange

The controller is now waiting for the primary code of the user.

4. Enter the primary code belonging to the user.

The Mode indicator flashes green.

Mode   Door  
Green Orange

5. Enter the assignment digit for the current user slot:

- **1** activates the Lock Strike relay only default
- **2** activates the Auxiliary relay only
- **3** activates the Lock Strike and Auxiliary relays

If the assignment digit is valid, three beeps are heard and the controller returns to Normal mode.

If the assignment digit is invalid, a long beep sounds and the controller waits for another assignment digit to be entered.

## 5.14 Changing PIN Code Length/Factory Default Settings



You must be very careful before using this command! Changing the PIN code length also erases the entire memory contents, including all user and special codes, and returns all codes to their factory default settings.

### *To change PIN code length:*

1. Enter Programming mode. Mode   Door Green
2. Select the desired PIN code length as follows:
  - **00** – Returns to factory defaults and sets a 4 digit code.
  - **05** – Returns to factory defaults and sets a 5 digit code.
  - **06** – Returns to factory defaults and sets a 6 digit code.
  - **08** – Returns to factory defaults and sets a 4-8 digit code.



When choosing the 4-8 option, please note that you should either enter zeros before the code, or press pound at the end (for example if your code is 12345, enter either **00012345** or **12345#**).

Both the Mode and Door indicators flash red.



3. Enter your Programming code.

If the Programming code is valid, all memory is erased. You hear three beeps and the controller returns to Normal mode.

If the Programming code is invalid, you hear a long beep and the controller returns to Normal mode without erasing the memory contents.

### 5.15 Replacing a Programming Code



The controller must be in Normal mode for the procedure to work. Insure that the Mode indicator is green before proceeding.

#### *To replace a Programming code:*

1. Remove power from the controller.
2. Press and hold the REX pushbutton.
3. Apply power to the unit with the REX pushbutton pressed.
4. Release the REX pushbutton.
5. You now have 15 seconds to program a new programming code into the unit using the initial default code before the controller reverts to the existing code.

The default code depends on the PIN length selected (see Table 2).

### 5.16 Replacing a Normal/Secure Code



The controller must be in its Secure mode for the procedure to work. Insure that the Mode indicator is red before proceeding.

#### *To replace a Normal/Secure code:*

1. Remove power from the controller.
2. Press and hold the REX pushbutton.
3. Apply power to the unit with the REX pushbutton pressed.
4. Release the REX pushbutton.  
You now have 15 seconds to use the Normal/Secure code to return to the Normal mode.
5. Once in Normal mode, enter the programming mode to program a new Normal/Secure code.

The default code depends on the PIN length selected (see Table 2).

### A. Limited Warranty

The full ROSSLARE Limited Warranty Statement is available in the Quick Links section on the ROSSLARE website at [www.rosslaresecurity.com](http://www.rosslaresecurity.com).

Rosslare considers any use of this product as agreement to the Warranty Terms even if you do not review them.



## Asia Pacific, Middle East, Africa

Rosslare Enterprises Ltd.

Kowloon Bay, Hong Kong

Tel: +852 2795-5630

Fax: +852 2795-1508

support.apac@rosslaresecurity.com

## United States and Canada

Rosslare Security Products, Inc.

Southlake, TX, USA

Toll Free: +1-866-632-1101

Local: +1-817-305-0006

Fax: +1-817-305-0069

support.na@rosslaresecurity.com

## Europe

Rosslare Israel Ltd.

Rosh HaAyin, Israel

Tel: +972 3 938-6838

Fax: +972 3 938-6830

support.eu@rosslaresecurity.com

## Latin America

Rosslare Latin America

Buenos Aires, Argentina

Tel: +54-11-4001-3104

support.la@rosslaresecurity.com

## China

Rosslare Electronics (Shenzhen) Ltd.

Shenzhen, China

Tel: +86 755 8610 6842

Fax: +86 755 8610 6101

support.cn@rosslaresecurity.com

## India

Rosslare Electronics India Pvt Ltd.

Tel/Fax: +91 20 40147830

Mobile: +91 9975768824

sales.in@rosslaresecurity.com

**ROSSLARE**  
SECURITY PRODUCTS  
[www.rosslaresecurity.com](http://www.rosslaresecurity.com)

